

Disusun oleh: 2 Belia, 18.3, Tegar Pagar

Pengertian Isometri 1

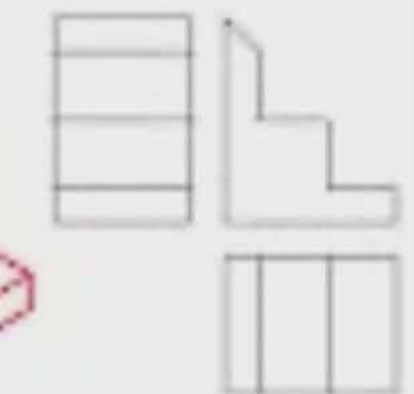

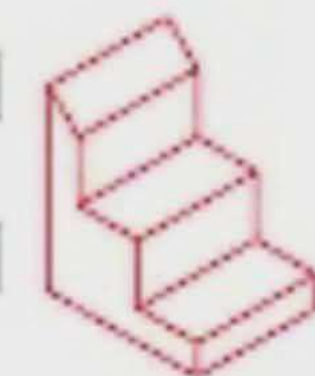
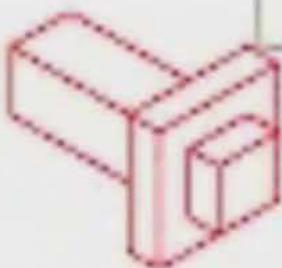
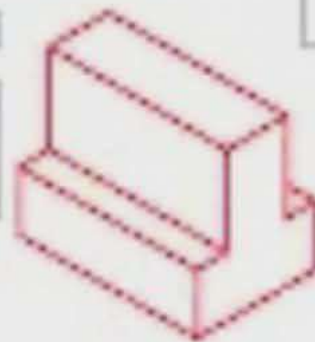
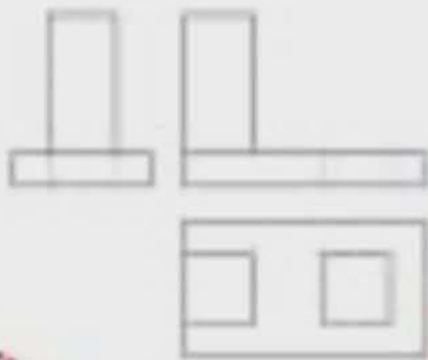
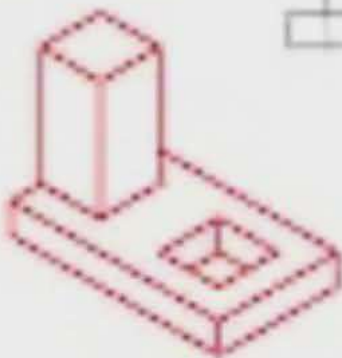
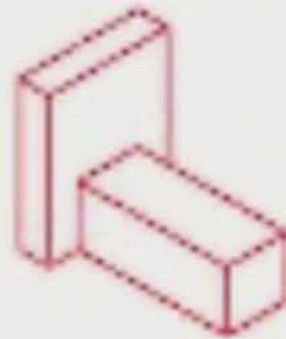
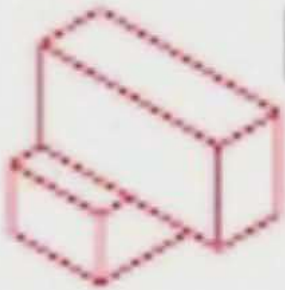
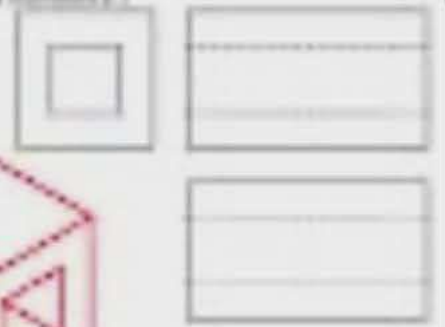
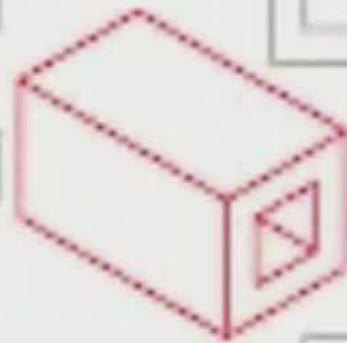
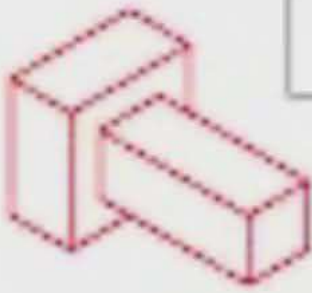
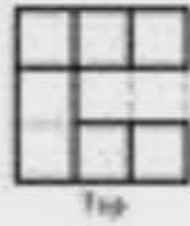
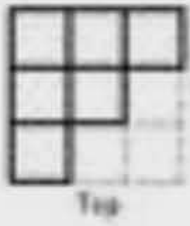

1

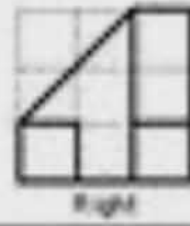
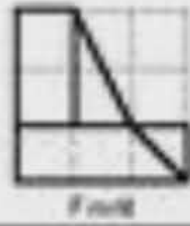

2

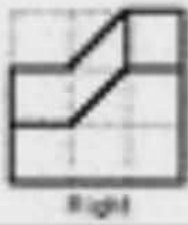
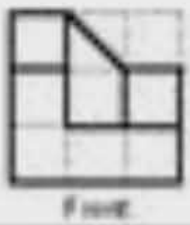
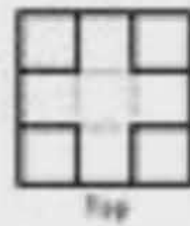
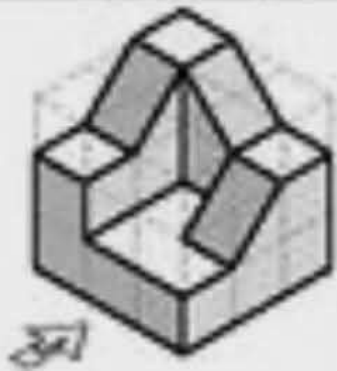
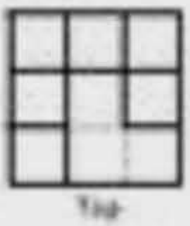

3



4

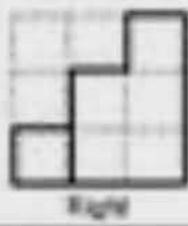
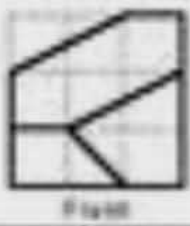
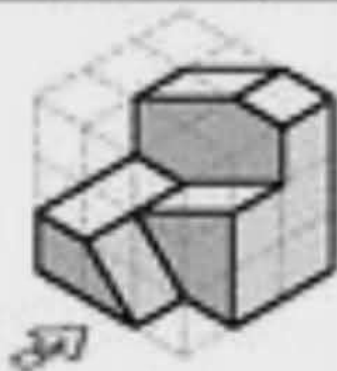
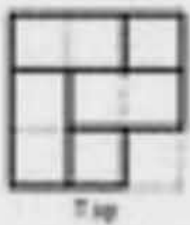

5

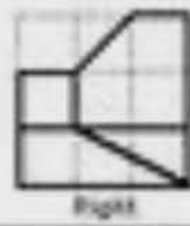
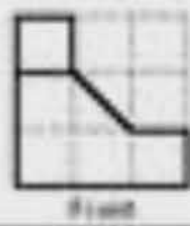

6

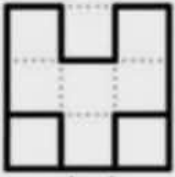

alzado



perfil

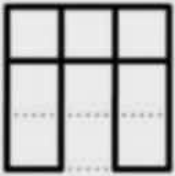

planta

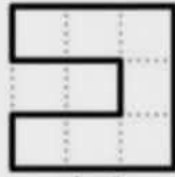
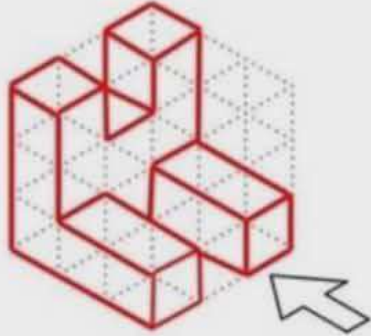

alzado

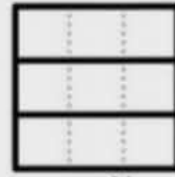

perfil

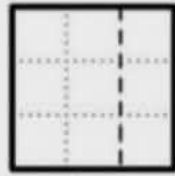

planta

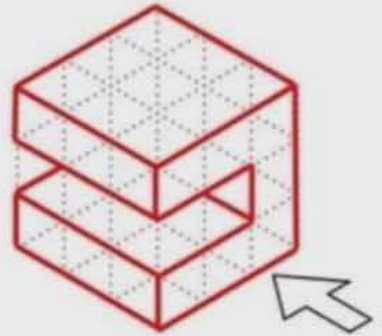

alzado

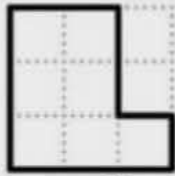

perfil



planta

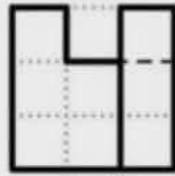
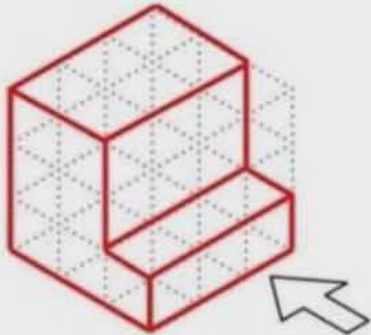

alzado

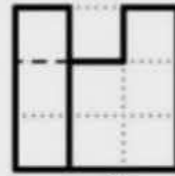

perfil

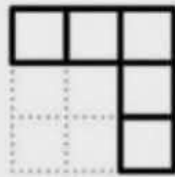

planta

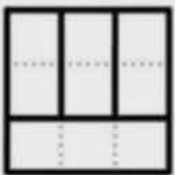
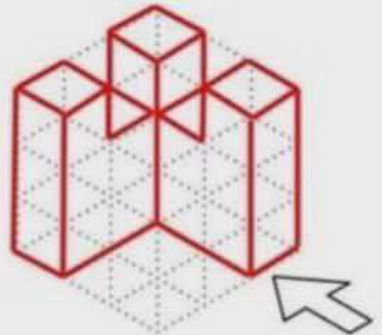

alzado

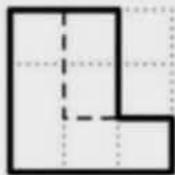

perfil

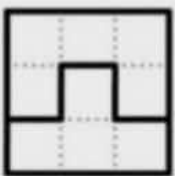

planta

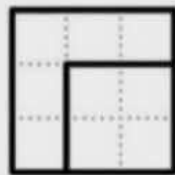
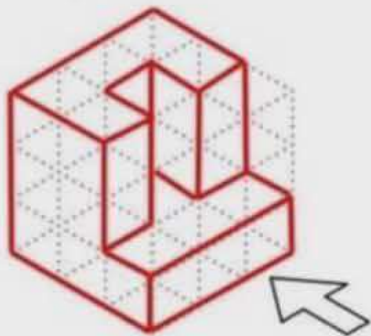

alzado

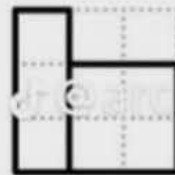

perfil

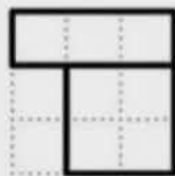

planta

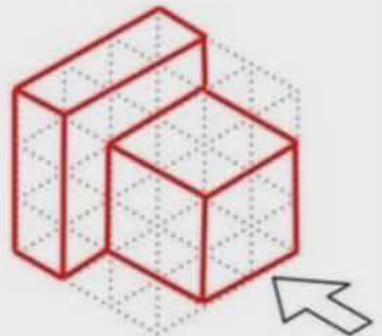

© annt.huma

EXERCISES. Transfer the letters from the isometric drawing onto the same plane surfaces of the orthogonal drawing. Name each view.

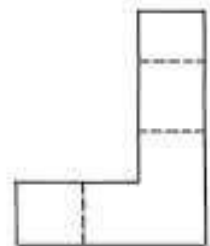
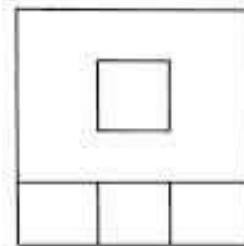
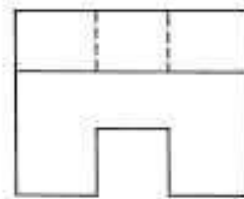
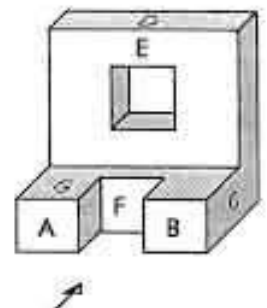
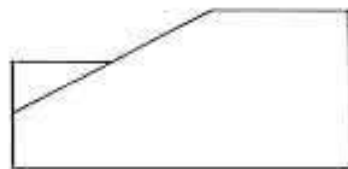
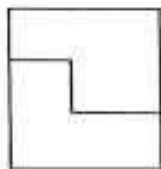
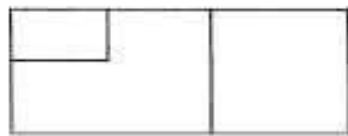
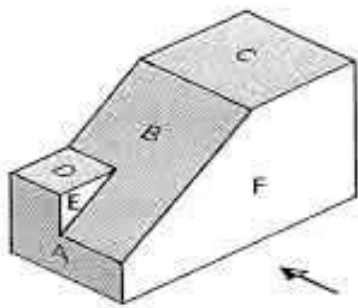

DRG. ORTHOGRAPHIC PROJECTION

EXERCISE 3

EXERCISES. From drawings 1 to 18 opposite select the view which is requested in the table below. Place the number of this view in the

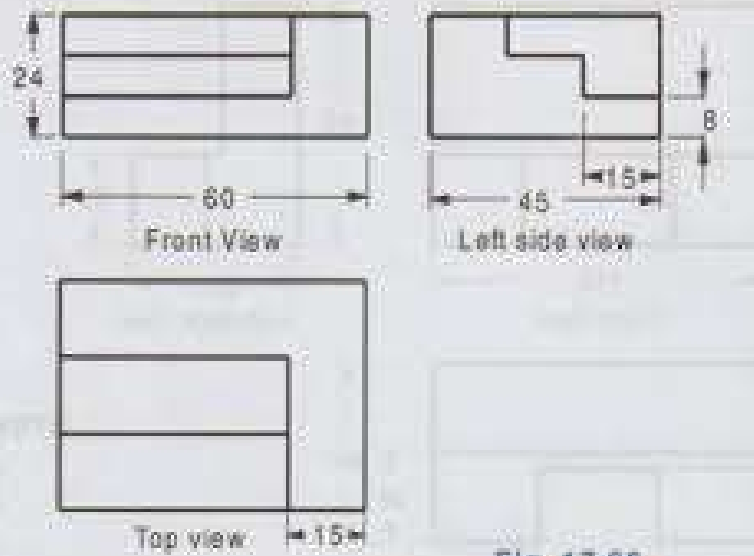

STEP-1

Determination of Dimensions
 Length = 60
 Breadth = 45
 Height = 24

Fig. 17.66

STEP-2

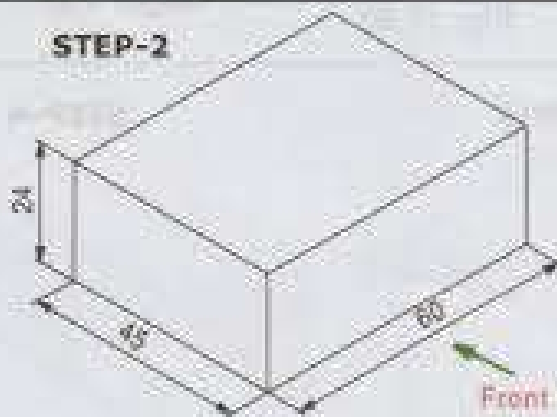

STEP-3

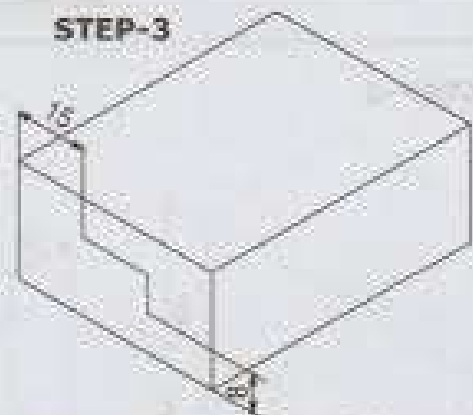

STEP-4

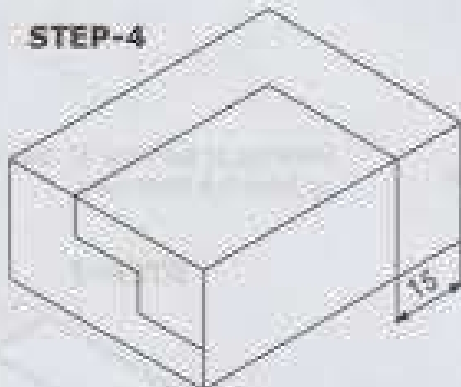

STEP-5

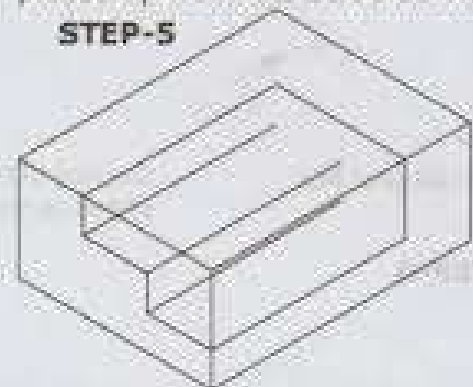

STEP-6

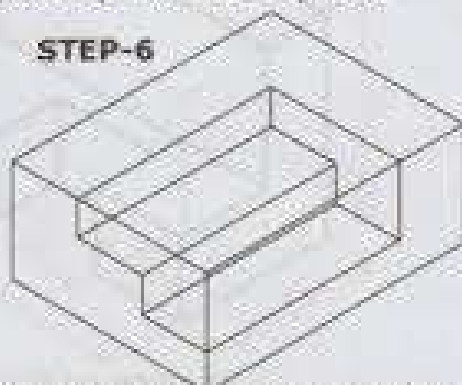

STEP-7

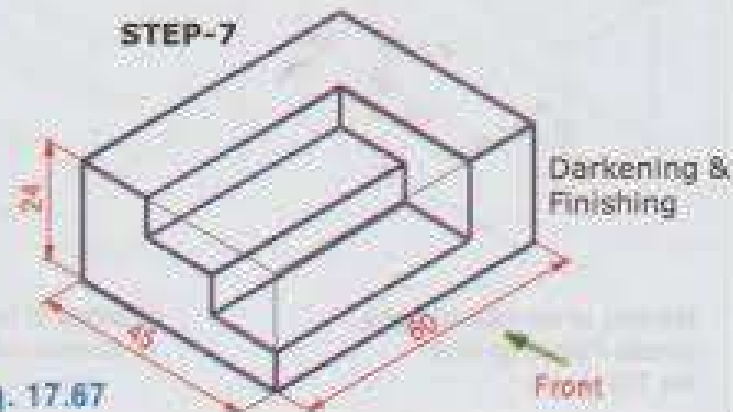
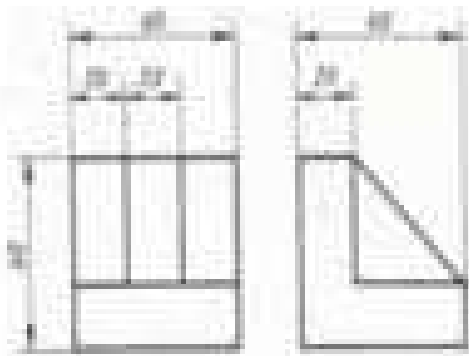
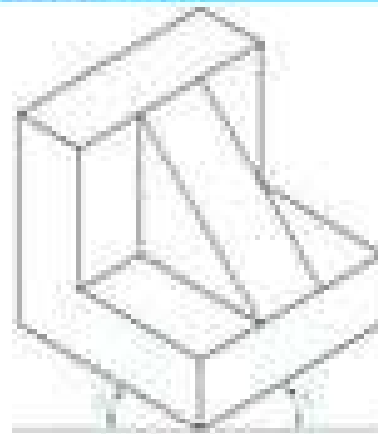

Fig. 17.67



Problem 84



Answer

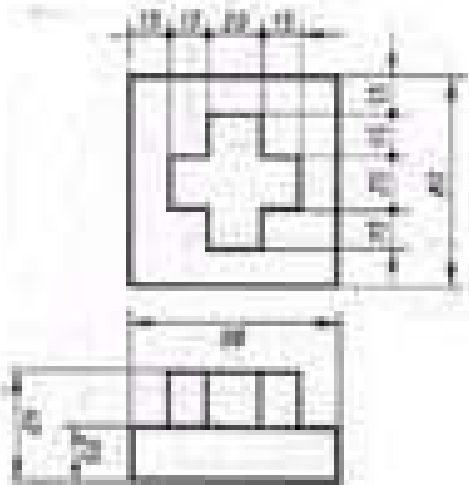

Problem 85

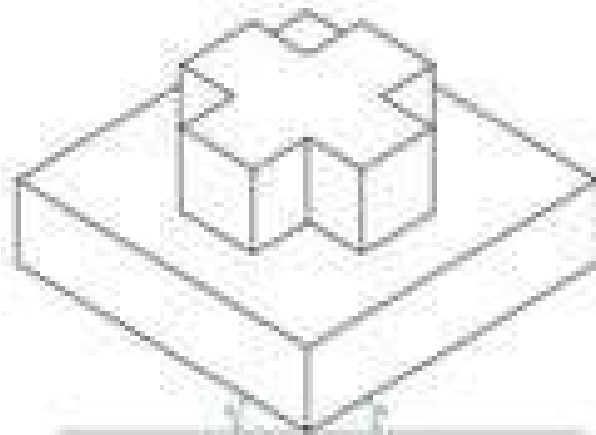

Answer

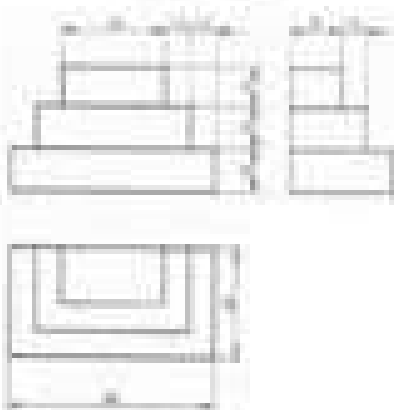

Problem 86

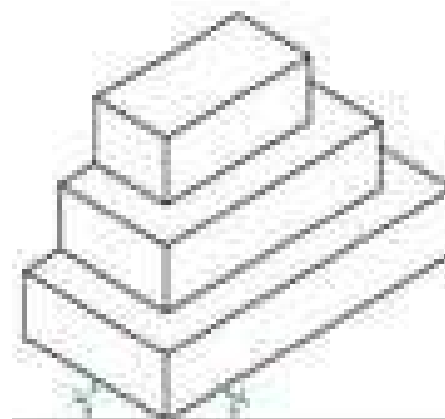

Answer

Orthographic Projection

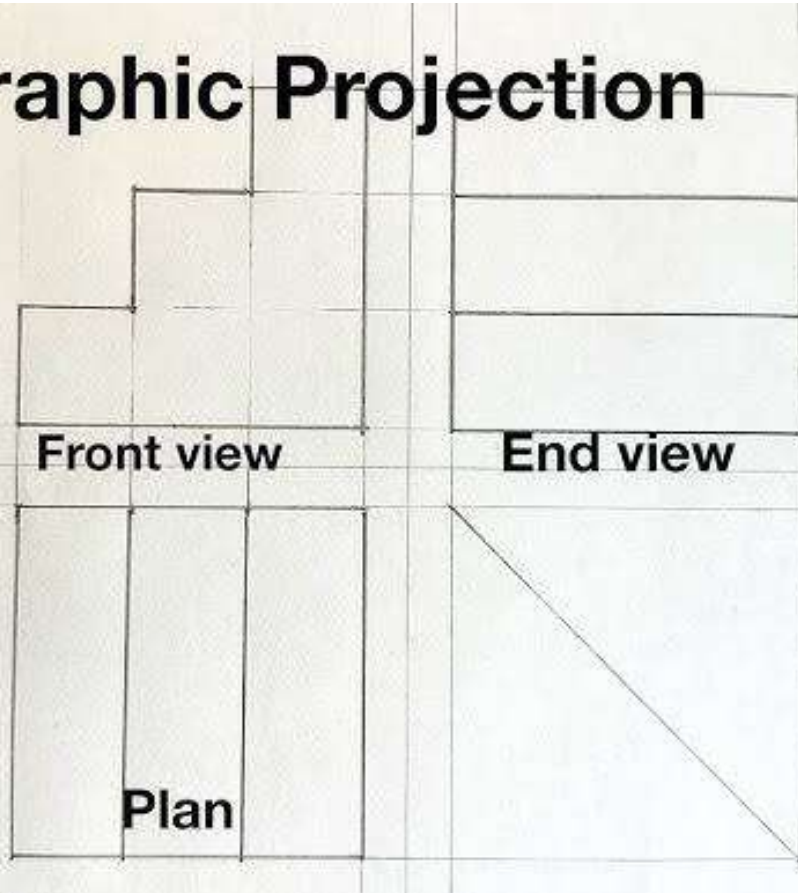
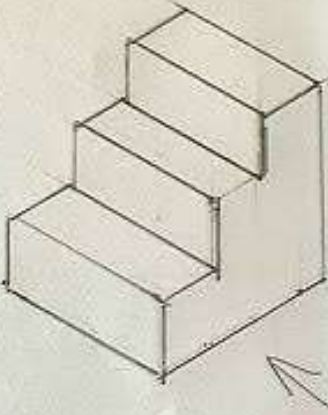

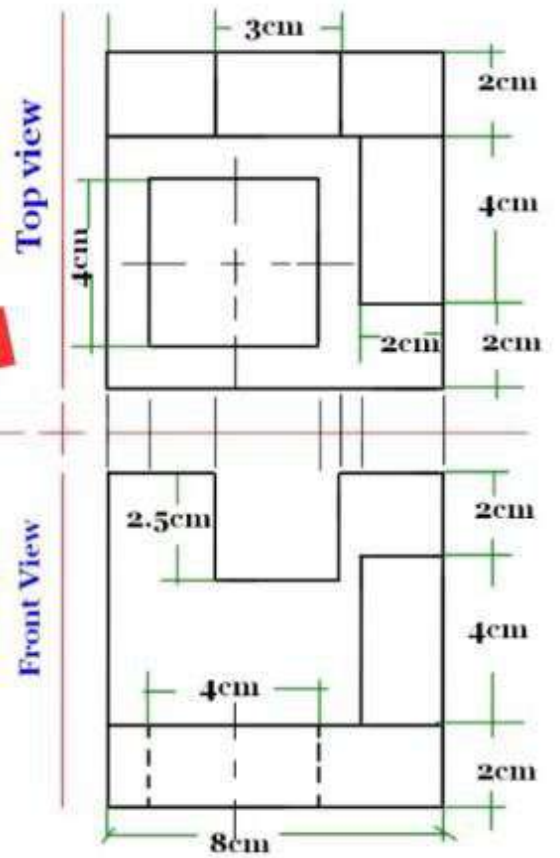
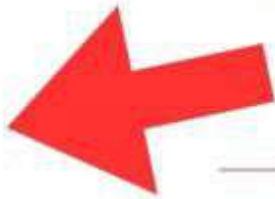
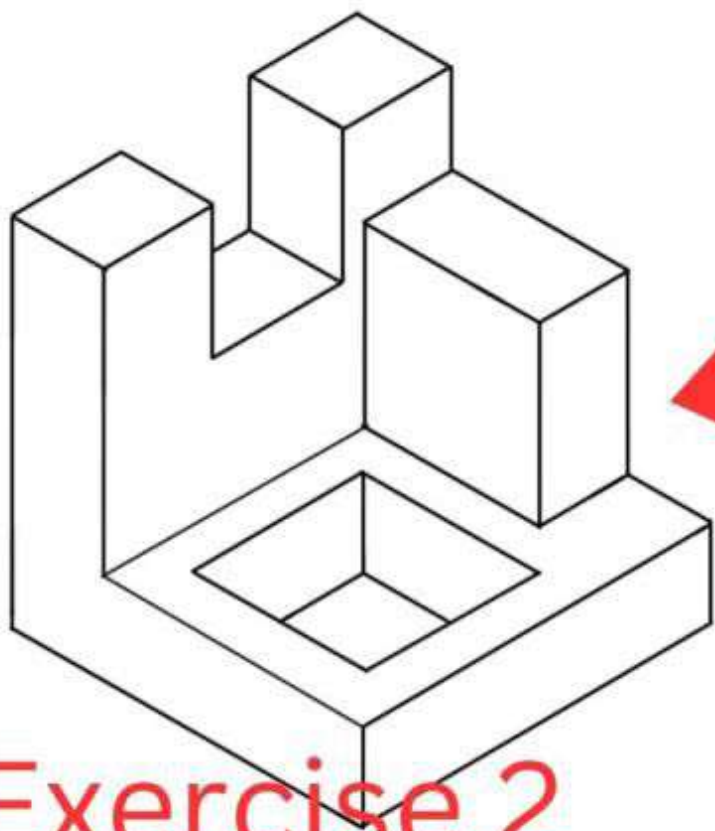

Exercise 2

Orthographic Projection

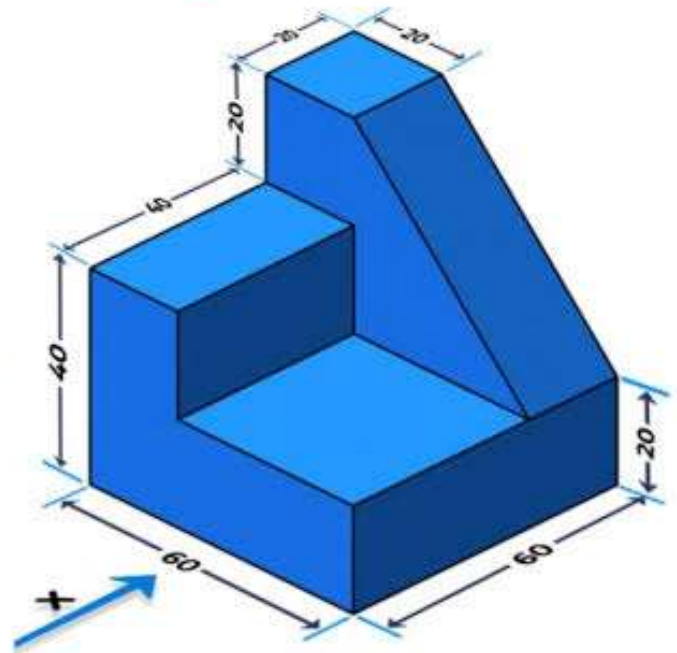
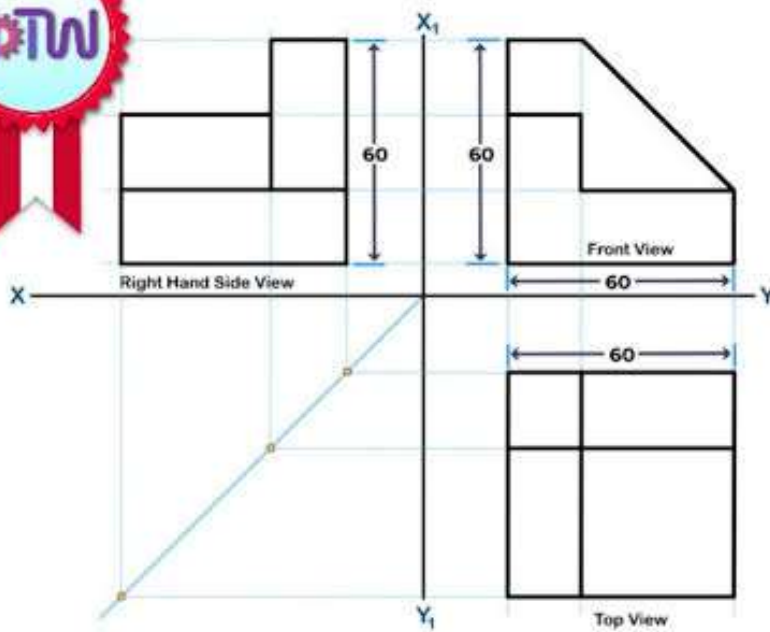

ISOMETRIC DRAWINGS

ORTHOGRAPHIC PROJECTION

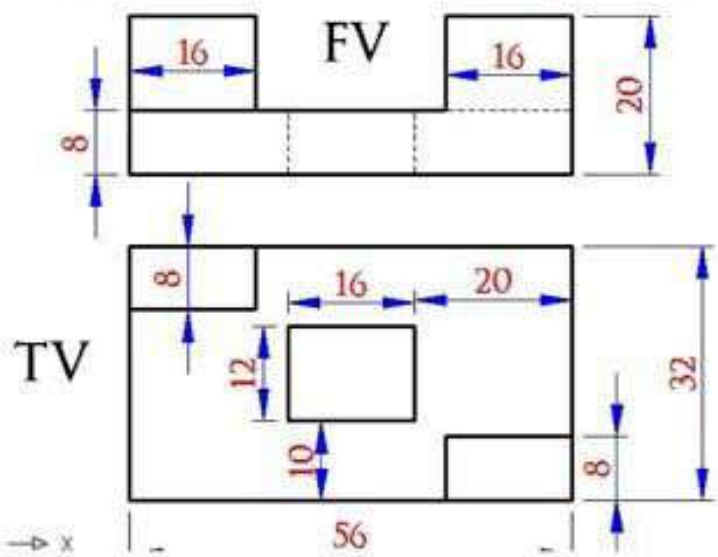

ISOMETRIC VIEW

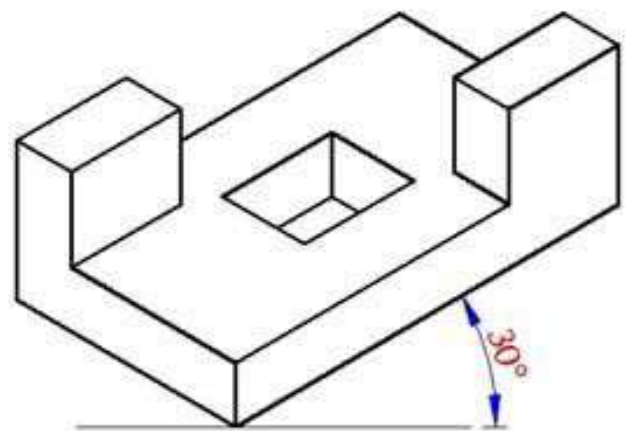

Vistas 4

Nombre alumno/a:

curso:

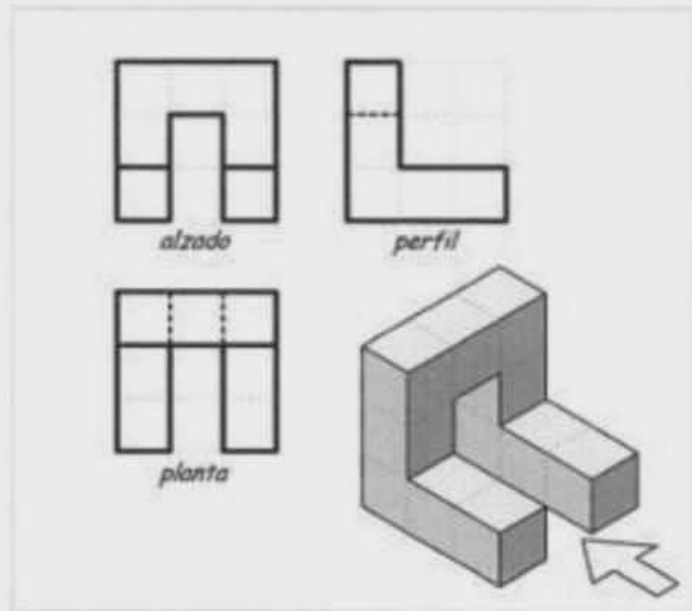
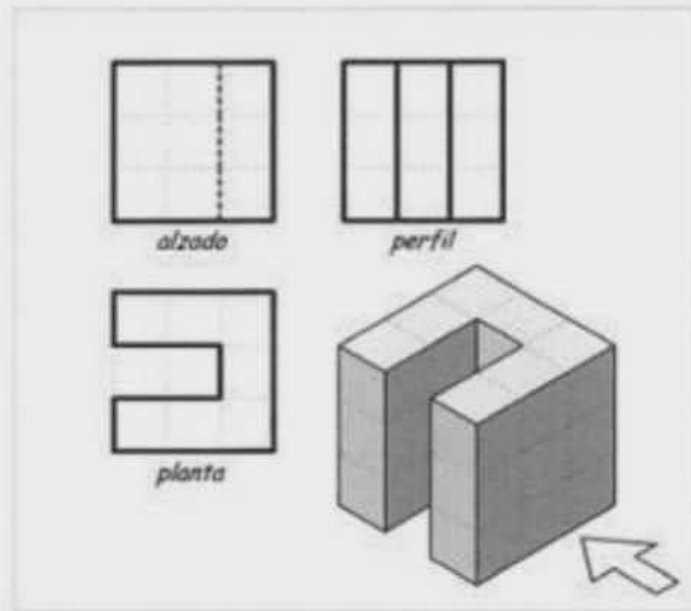
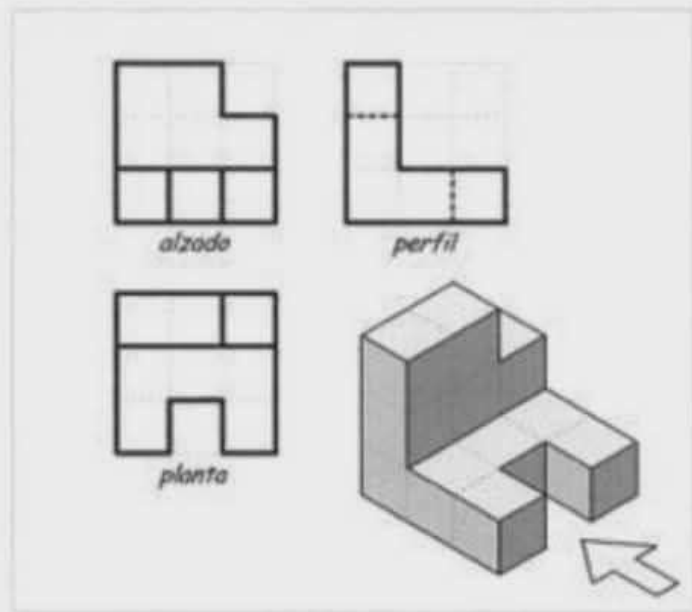
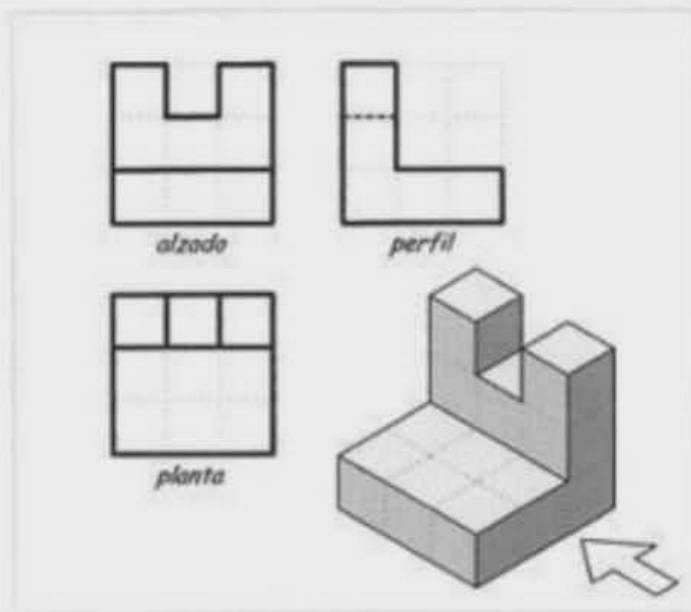
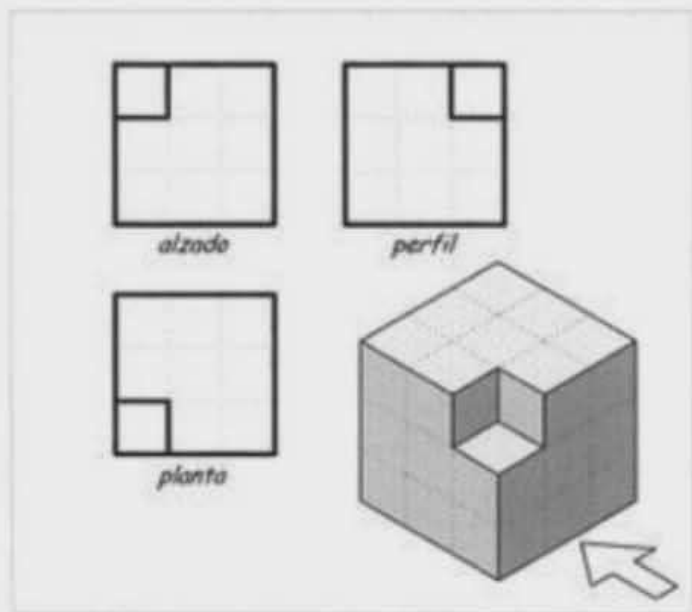
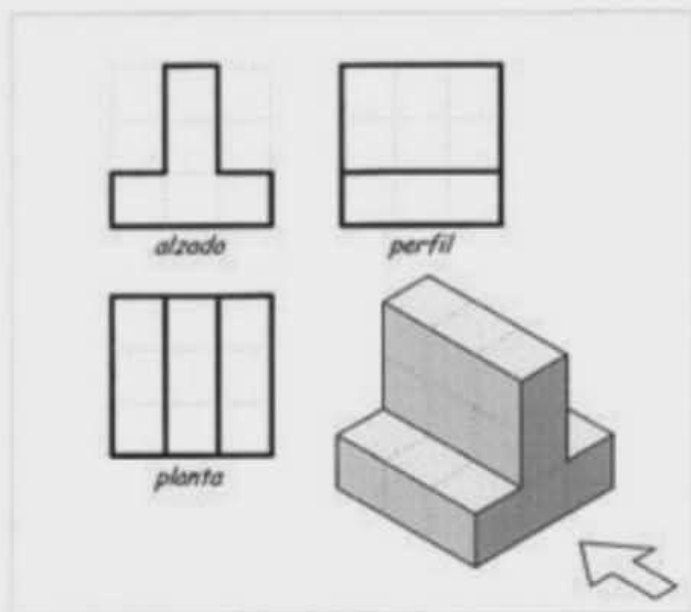

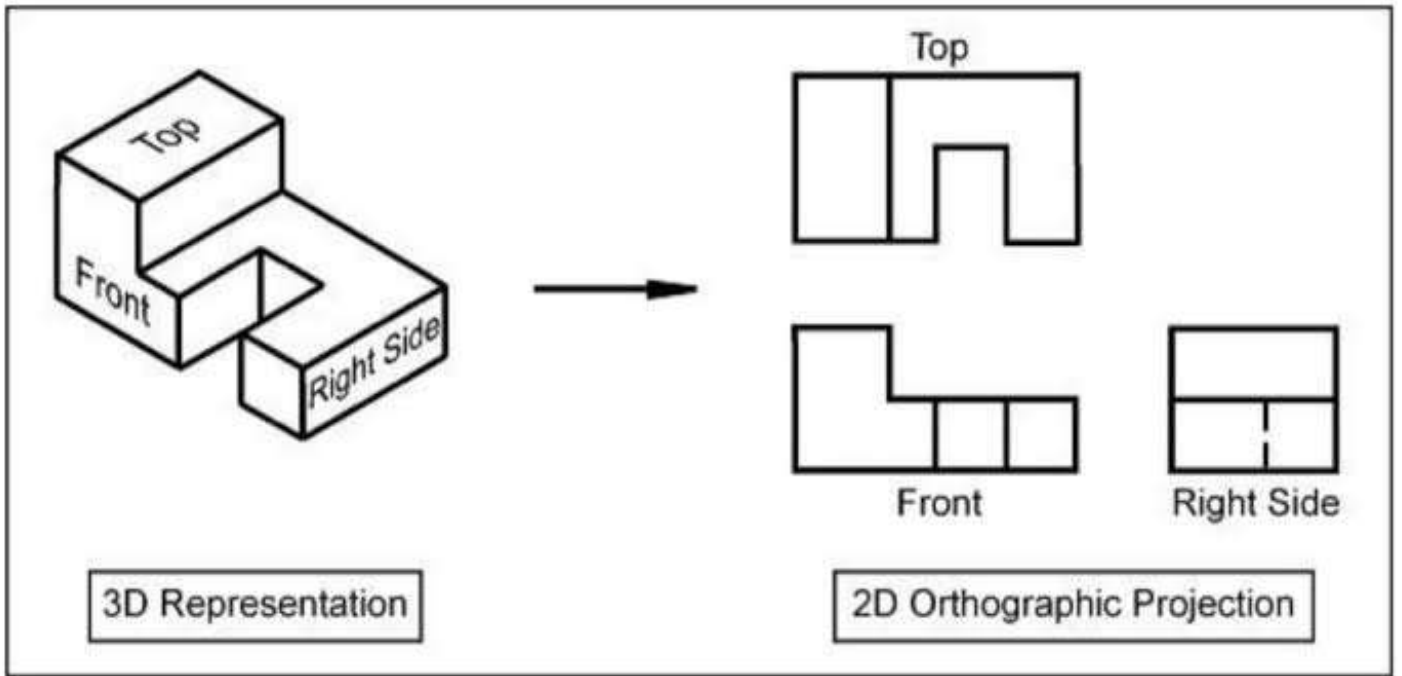

Isometric Drawing

2D Orthographic Projection

Vistas 1

Nombre alumno:

Fecha:

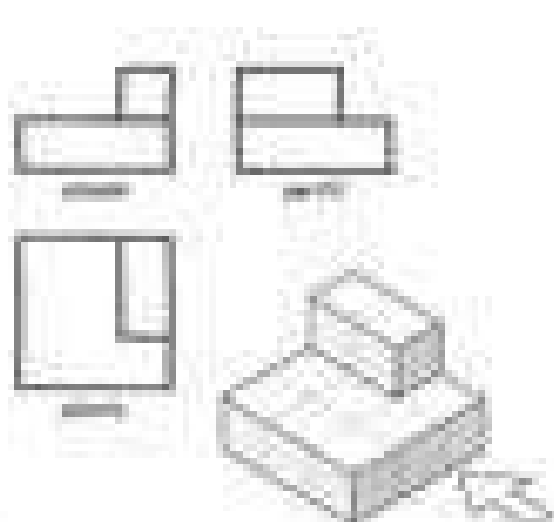
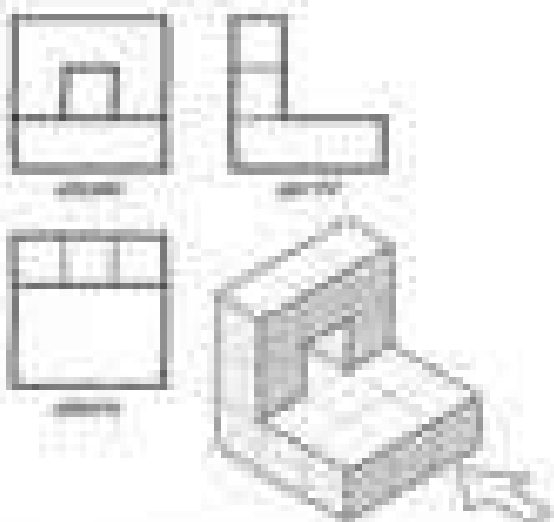
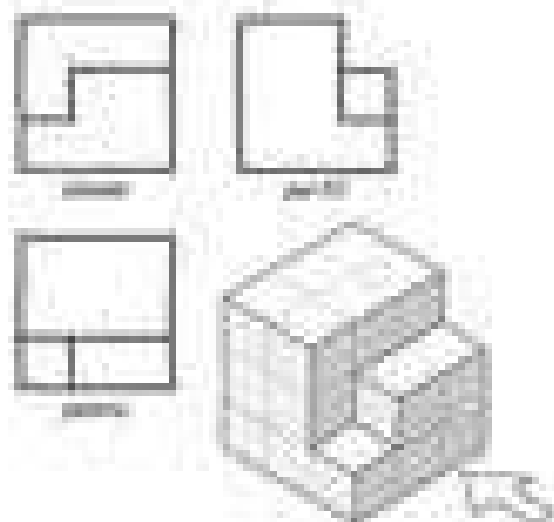
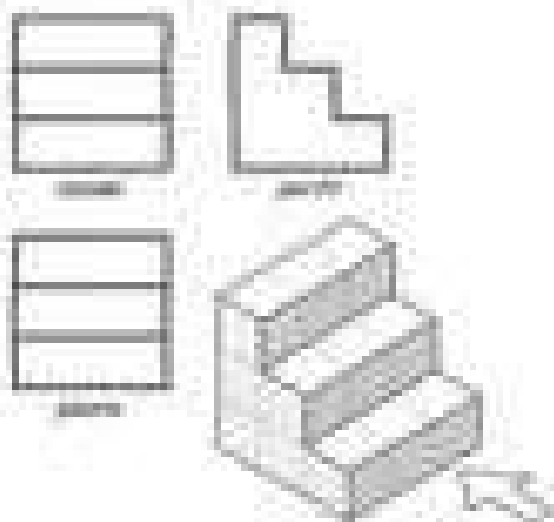
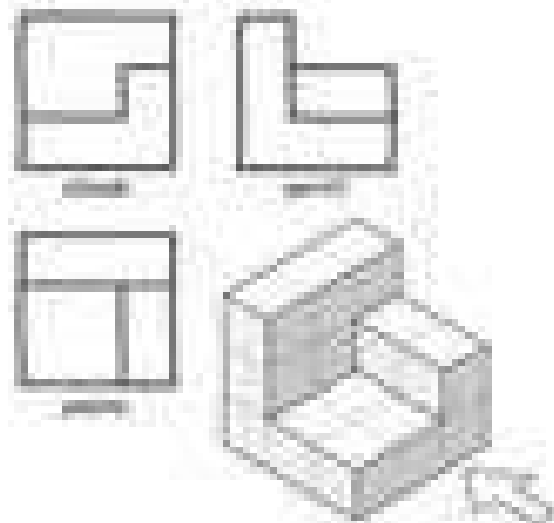
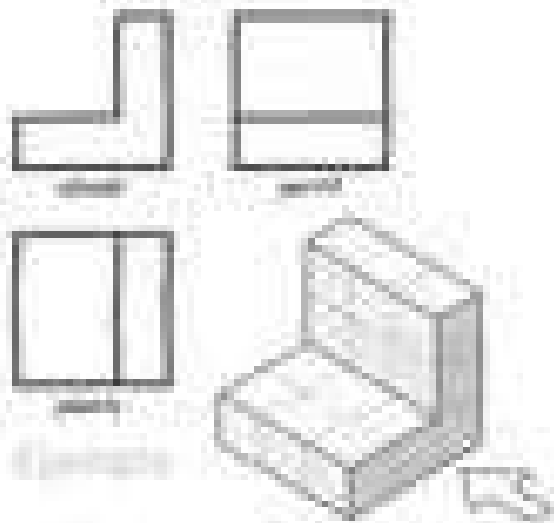

Orthographic Projection

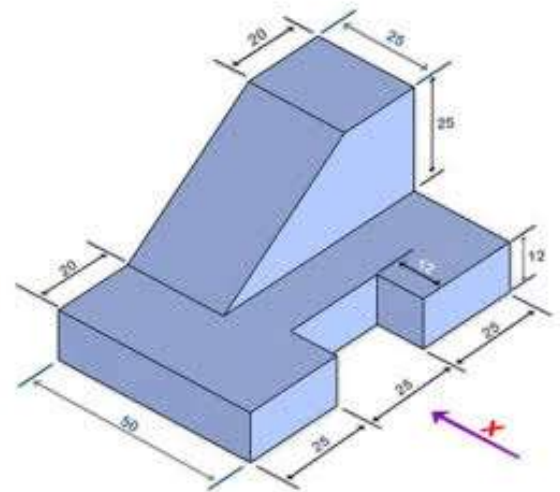
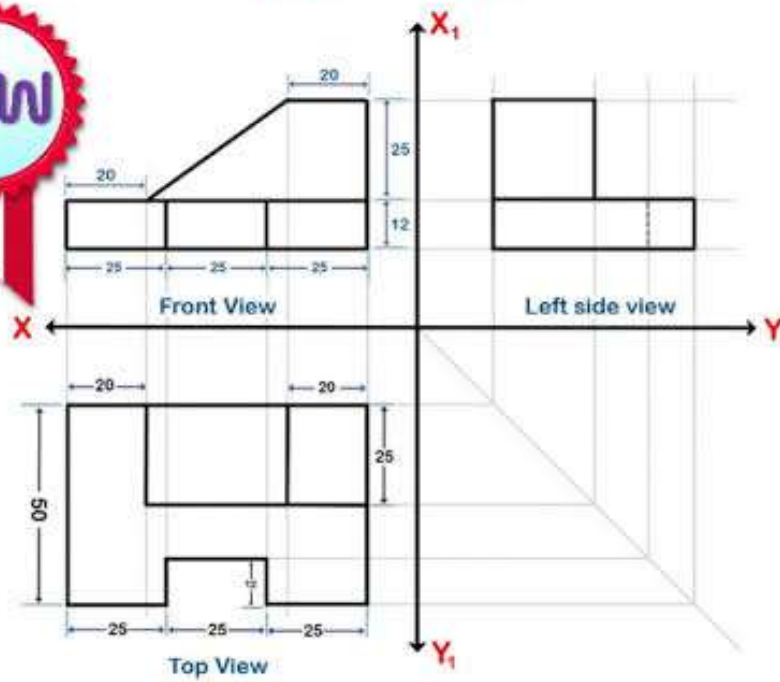

Isometric View

PERSPECTIVA DOME TRICA II

Dibuje estos objetos
fijando que cada uno es una
modificación de lo anterior

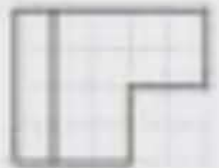
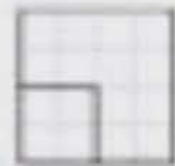
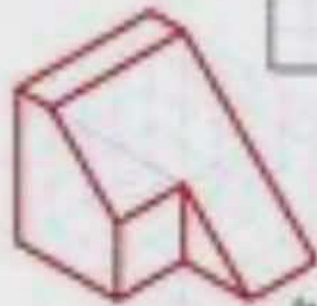
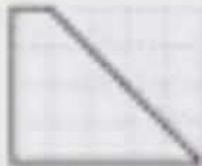
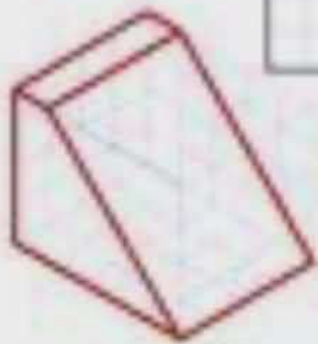

En estos casos, siempre se le ha cortado
un trozo

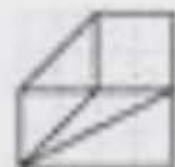
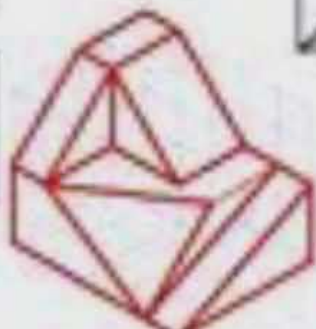
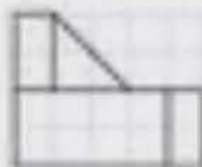
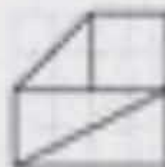
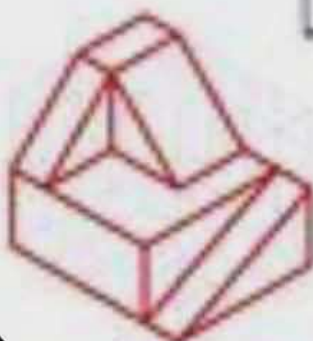
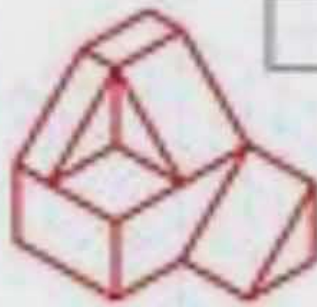
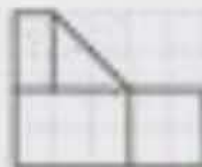
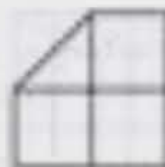
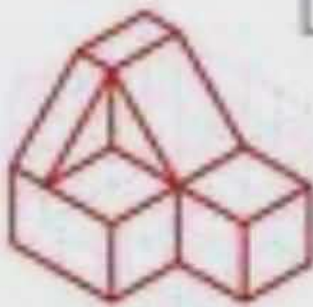
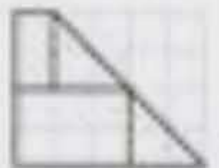
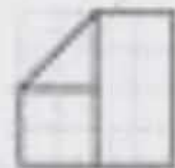
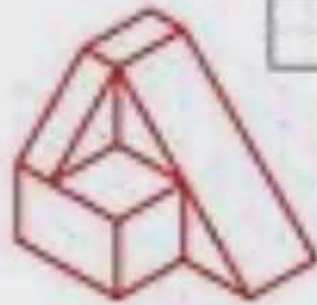
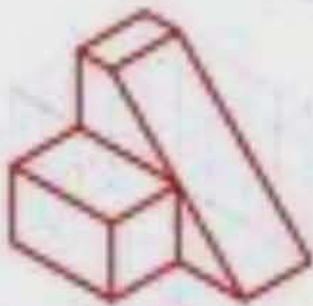

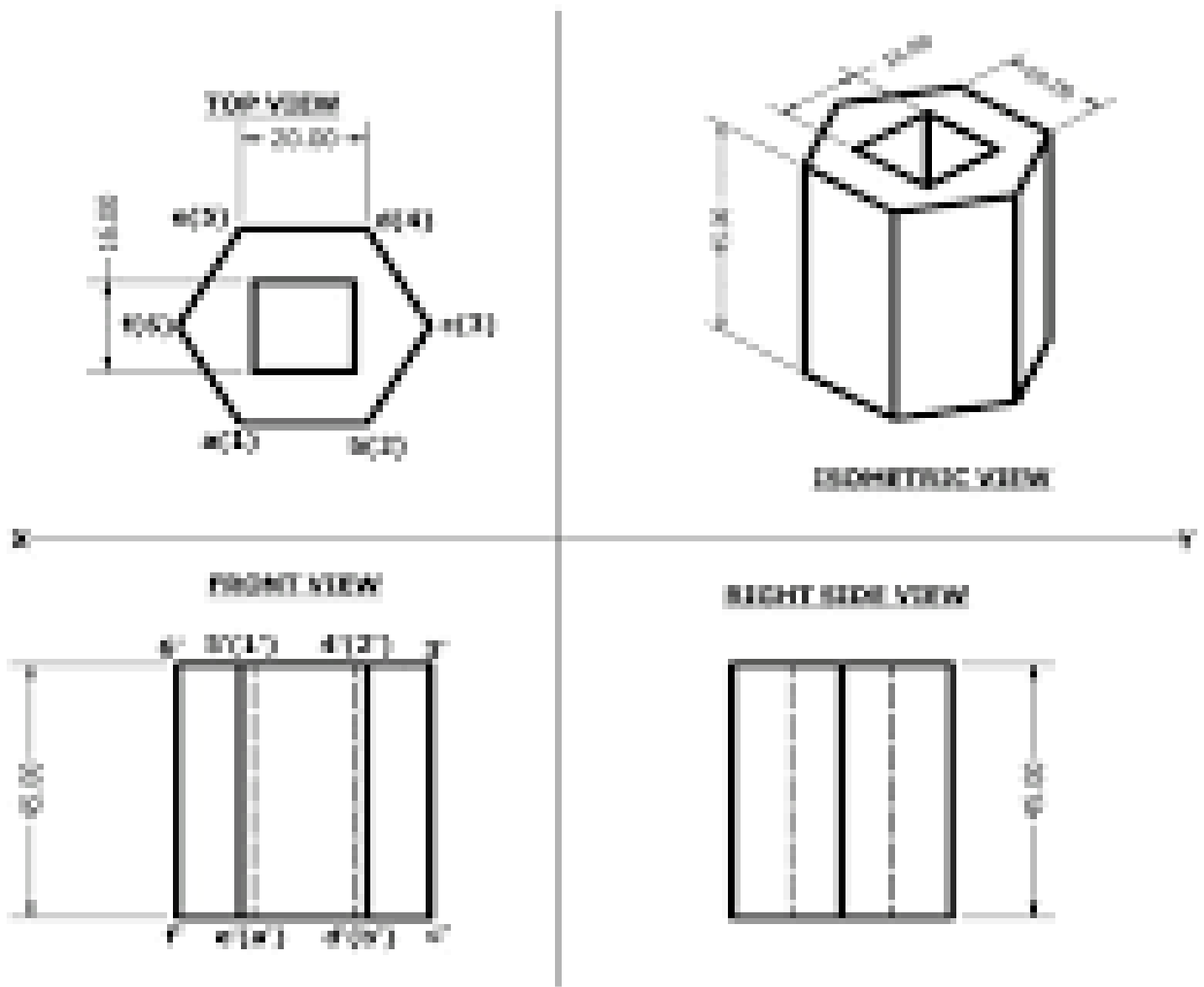

FIGURE 3B.1 THREE-ANGLE PROJECTION